

Form 18302-- Revised
August, 1931
PRINTED IN U. S. A.

LIST OF PARTS

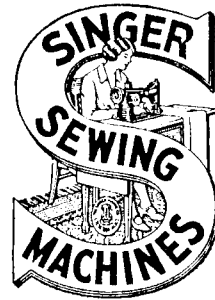

MACHINE No. 112-4

THE SINGER MANUFACTURING COMPANY

From the library of: Diamond Needle Corp

COPYRIGHT, U. S. A.,
1922, 1924, 1926, 1928 AND 1931,
BY THE SINGER MANUFACTURING COMPANY
ALL RIGHTS RESERVED FOR ALL COUNTRIES

INDEX

	PAGE
ACCESSORIES.....	19
FITTINGS FOR $\frac{1}{8}$ INCH THROW.....	16
FOOT LIFTER PARTS.....	19
KNEE LIFTER PARTS.....	20
MACHINE BASE.....	19
MACHINE NO. 112-4.....	7
NUMERICAL LIST OF PARTS.....	23
OBSOLETE PARTS.....	22
SPECIAL FITTINGS.....	17
TABLE SUPPORT PARTS.....	21
THREAD UNWINDER.....	21

From the library of: Diamond Needle Corp

INSTRUCTIONS FOR ORDERING

In ordering from this list, use **ONLY** the part NUMBER in the **FIRST** column.

The number stamped on a Sewing Machine Part is in every case the number of the single part only.

Every combination of parts sent out as such has its specific number, which, although not stamped on the parts, must be used when ordering the combination.

Each number always indicates the **SAME PART** in whatever list it appears, or for whatever machine.

The letters after some of the numbers indicate the style of finish only, as follows:

- A—Hardened, Polished, Nickel Plated and Buffed
- B—Polished, Nickel Plated and Buffed
- C—Hardened Only
- D—Polished Only
- E—Soft, Not Polished
- F—Hardened and Polished
- H—Blued
- J—Nickel Plated Only
- K—Hardened and Nickel Plated
- L—Brass Plated
- M—Oxidized
- N—Japanned, Dull
- P—Japanned, Bright
- R—Merlized
- T—Copper Plated
- T. A.—Hardened, Polished, Copper and Nickel Plated and Buffed
- T. B.—Copper and Nickel Plated and Polished
- T. J.—Copper and Nickel Plated Only
- T. K.—Hardened, Copper and Nickel Plated
- T. M.—Copper Plated and Oxidized
- T. L.—Copper and Brass Plated
- U—Zinc Plated
- V—Silver Plated
- W—Polished and Nickel Plated
- Z—Chromium Plated
- Z. B.—Polished, Nickel Plated, Buffed and Chromium Plated
- Z. J.—Nickel and Chromium Plated

These letters **MUST BE USED** when they appear in the list; and **AFTER** the number **as** in the list.

In this series:

- 1 to 1500 and 50001 to 51500 are Screw Numbers
- 1501 to 1800 and 51501 to 51800 are Nut Numbers
- 1801 to 2000 and 51801 to 52000 are Roller Numbers
- 2001 to 50000 and 52001 and upward are numbers of Machine Parts

The figures in the second column refer only to the plates, illustrating the parts, and are **NOT TO BE USED** in ordering.

Parts marked with an asterisk (*) are furnished only when repairs are made at factory.

LIST OF PARTS COMPLETE

FOR

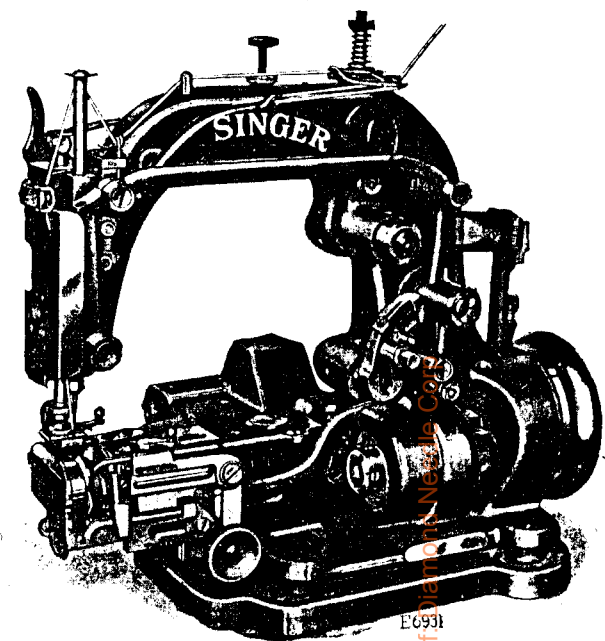

MACHINE No. 112-4

FOR ABUTTING AND STITCHING VARIOUS WIDTHS OF RIBBONS, STRAW BRAID WITH FINISHED EDGE AND PYROXLIN BRAID; ALSO FABRIC STRIPS USED IN THE MANUFACTURE OF HATS. OVERSEAMING ZIGZAG SINGLE-THREAD CHAIN STITCH; THE NEEDLE VIBRATES UP TO $\frac{1}{8}$ INCH. MAKES FROM 8 TO 24 STITCHES TO THE INCH. DROP FEED; FEED DOGS AND PRESSER FEET FOR DIFFERENT VARIETIES OF BRAID. ADJUSTABLE GUIDE FOR DIFFERENT WIDTHS OF BRAID. TIPPER. BRAID DIVIDING FINGER HINGED TO THROW OUT WHILE MAKING THE BUTTON OF THE HAT. COMPOUND TENSION. SELF-SETTING NEEDLE. FLAT COMBINATION BASE AND DRIP PAN IN PLACE OF THE ADJUSTABLE BASE. BALANCE WHEEL AND NEEDLE BAR LEVER ECCENTRIC NO. 64807. DIAMETER OF BELT GROOVE $2\frac{1}{8}$ INCHES. SPEED 2800.

NO.	PLATE	NAME
*64882	—	Arm, upper and lower (solid).....
34461	8511	“ End Cover and Belt Guard.....
207J	8507	“ “ “ “ “ “ Screw..

NO.	PLATE	NAME
64802	8511	Arm Rotary Shaft.....
64803	8512	“ “ “ Bushing (front).....
1036c	8507	“ “ “ “ “ Set Screw.....
64804	8511	Arm Rotary Shaft Flanged Bushing (back) with 64805.....
64805	8524	Arm Rotary Shaft Flanged Bushing (back) Oil Pad (braided cotton).....
1036c	8507	Arm Rotary Shaft Flanged Bushing (back) Set Screw.....
64806	8512	Arm Rotary Shaft Gear with two 200F....
200F	8512	“ “ “ “ Set Screw.....
64807	8511	Balance Wheel and Needle Bar Lever Eccentric with 430c and 1285c.....
64869	—	Balance Wheel and Needle Bar Lever Eccentric 64807 with 42074 and 64846..
64951	—	Balance Wheel and Needle Bar Lever Eccentric 64869 with 171j, 34461 and 42077.....
1285c	8507	Balance Wheel and Needle Bar Lever Eccentric Position Screw.....
430c	8507	Balance Wheel and Needle Bar Lever Eccentric Set Screw.....
68531	9309	Face Plate.....
330F	8507	“ “ Screw.....
64931	8511	Feed Bar.....
68516	—	“ “ 64931 with 64812 and 64820....
64810	8512	“ “ Connecting Link.....
50683c	8512	“ “ “ “ Hinge Screw ..
1655e	8512	“ “ “ “ “ Nut
64883	8522	“ “ Cover.....
176j	8507	“ “ Screw.....
64812	8512	“ “ Hinge Stud.....
1147c	8524	“ “ “ “ Set Screw.....
64926	8512	“ Connecting Rod with 1012e, 68544 and two 1057E.....
1012E	8512	Feed Connecting Rod Adjusting Screw...
*68544	—	“ “ “ Cap.....
1057E	8512	“ “ “ “ Screw.....
64904	8524	“ Dog (fine) 14 teeth (16 teeth to the inch).....
64928	8524	Feed Dog (medium) 14 teeth (16 teeth to the inch).....
64936	8524	Feed Dog (coarse) 9 teeth (10 teeth to the inch).....
64939	8524	Feed Dog Carrier.....
64940	—	“ “ “ 64939 with 995c.....

NO.	PLATE	NAME
19020	8512	Feed Dog Carrier Friction Spring.....
22411	8512	“ “ “ “ “ Washer
995c	8512	“ “ “ Regulating Thumb Screw.....
996c	8512	Feed Dog Carrier Screw.....
997c	8512	“ “ Screw.....
64927	8512	“ Eccentric with two 452c.....
452c	8507	“ “ Set Screw.....
64814	8512	“ Lifting Eccentric with 452c and 462c
64815	8512	“ “ “ Connection with 171E and 59019.....
171E	8512	Feed Lifting Eccentric Connection Adjusting Screw.....
59019	8512	Feed Lifting Eccentric Connection Gib...
50562c	8512	“ “ “ “ Hinge Screw.....
1520E	8512	Feed Lifting Eccentric Connection Hinge Screw Nut.....
452c	8507	Feed Lifting Eccentric Position Screw....
462c	8512	“ “ “ Set Screw.....
64816	8511	“ “ Rock Shaft.....
64817	8512	“ “ “ “ Bushing.....
1036c	8507	“ “ “ “ “ Set Screw
64818	8514	“ “ “ “ Crank (back) with 157E.....
157E	8514	Feed Lifting Rock Shaft Crank (back) Clamping Screw.....
64819	8514	Feed Lifting Rock Shaft Crank (front) with 157E, 1655E and 50683c.....
157E	8514	Feed Lifting Rock Shaft Crank (front) Clamping Screw.....
1027c	8514	Feed Regulating Screw Stud.....
1627c	8514	“ “ “ “ Nut.....
42290	8514	“ “ “ “ Washer....
64820	8511	“ Rocking Frame with two each 452c and 1147c.....
59211	8511	Feed Rocking Frame Hinge Pin.....
64821	8514	“ “ “ “ “ Bushing..
1036c	8507	“ “ “ “ “ “ Set Screw.....
452c	8507	Feed Rocking Frame Hinge Pin Set Screw.
64980	8524	Guide, for cording and soutache braid....
68519	9307	Looper.....
64905	8514	“ Gate.....
1240c	8514	“ “ Hinge Screw.....
64932	8524	“ “ Latch Spring.....
337j	8514	“ “ “ “ Screw.....

NO.	PLATE	NAME
64906	8514	Looper Gate Spring.....
111L	8514	“ “ “ Screw.....
64825	8514	“ Shaft with 462c.....
64826	8514	“ “ Carrier.....
64827	8514	“ “ “ Bushing.....
68523	9309	“ “ “ “ with needle hole strip support, for repairs.....
846c	8514	Looper Shaft Carrier Bushing Set Screw..
64828	8504	“ “ “ Pitman.....
64874	—	“ “ “ “ 64828 with 1520E and 50562c.....
1132e	8507	Looper Shaft Carrier Pitman Hinge Screw (left).....
50562c	8512	Looper Shaft Carrier Pitman Hinge Screw (right).....
1520E	8512	Looper Shaft Carrier Pitman Hinge Screw (right) Nut.....
64829	8514	Looper Shaft Coupling with two 462c....
462c	8512	“ “ “ Set Screw.....
462c	8512	“ Set Screw.....
64885	8515	Needle Bar (hollow) with 50165F and 64850.....
64831	8515	Needle Bar Connecting Bracket with 1056F and 50203E.....
68508	—	Needle Bar Connecting Bracket 64831 with 42055 and 64990.....
50203E	8515	Needle Bar Connecting Bracket Clamp- ing Screw.....
42055	8515	Needle Bar Connecting Link.....
64990	8524	“ “ “ “ Hinge Pin ..
1056F	8515	“ “ “ “ “ “ Set Screw.....
64832	8504	Needle Bar Frame.....
64833	8504	“ “ “ Cam and Gear.....
64834	8504	“ “ “ “ “ “ Cover 176J 8507 Screw.....
64835	8504	Needle Bar Frame Cam and Gear Stud (eccentric).....
64836	8515	Needle Bar Frame Cam and Gear Stud Collar with two 1259c.....
1259c	8515	Needle Bar Frame Cam and Gear Stud Collar Set Screw.....
1036c	8507	Needle Bar Frame Cam and Gear Stud Set Screw.....
68512	9301	Needle Bar Frame Driving Lever.....

NO.	PLATE	NAME
64838	8515	Needle Bar Frame Driving Lever Connect- ing Link with 1012J and 59019.....
64871	—	Needle Bar Frame Driving Lever Connect- ing Link 64838 with 1520E and 50562c..
1012J	8512	Needle Bar Frame Driving Lever Connect- ing Link Adjusting Screw.....
59019	8512	Needle Bar Frame Driving Lever Connect- ing Link Gib.....
50562c	8512	Needle Bar Frame Driving Lever Connect- ing Link Hinge Screw.....
1520E	8512	Needle Bar Frame Driving Lever Connect- ing Link Hinge Screw Nut.....
68513	9301	Needle Bar Frame Driving Lever Hinge Stud.....
68514	9301	Needle Bar Frame Driving Lever Hinge Stud Collar with two 1258c.....
1258c	8524	Needle Bar Frame Driving Lever Hinge Stud Collar Set Screw.....
1610c	9301	Needle Bar Frame Driving Lever Hinge Stud Nut.....
64942	8521	Needle Bar Frame Guide with 50090J....
176J	8507	“ “ “ “ Screw.....
37583	8515	“ “ “ Hinge Stud.....
1036c	8507	“ “ “ “ “ Set Screw.
64841	8504	“ “ “ Pitman.....
64875	—	“ “ “ “ 64841 with two each 1520E and 50562c.....
50562c	8512	Needle Bar Frame Pitman Hinge Screw..
1520E	8512	“ “ “ “ “ “ Nut
64952	9301	“ “ “ Regulator with 1277E and two 1120c.....
64979	—	Needle Bar Frame Regulator 64952 with 220J, 1680c, 7806 and 64844.....
64945	8518	Needle Bar Frame Regulator Hinge Stud
64949	—	“ “ “ “ “ “ 64945 with 64946.....
64946	8521	Needle Bar Frame Regulator Hinge Stud Bushings.....
1259c	8515	Needle Bar Frame Regulator Hinge Stud Bushings Set Screw.....
51874	9307	Needle Bar Frame Regulator Roller and Screw Stud (double roller).....
64844	8515	Needle Bar Frame Regulator Stop.....
220J	8515	“ “ “ “ “ Screw
7806	8515	“ “ “ “ “ “ Washer.....
1120c	8507	Needle Bar Frame Regulator Set Screw.

NO.	PLATE	NAME
1374c	8515	Needle Bar Frame Regulating Screw Stud
1680c	8515	" " " " " "
		Nut.....
1277e	9301	Needle Bar Frame Regulating Screw Stud Nut Stop Screw.....
42290	8514	Needle Bar Frame Regulating Screw Stud Washer.....
64845	8522	Needle Bar Lever with 1056e and two 1036c.....
64873	—	Needle Bar Lever 64845 with 64990 and 68508.....
42074	8515	Needle Bar Lever Ball Stud.....
1036c	8507	" " " " " Set Screw...
64846	8504	" " " Connecting Rod with 42059, 64847, 64848 and four 896e....
*64847	—	Needle Bar Lever Connecting Rod Cap (lower).....
896e	8507	Needle Bar Lever Connecting Rod Cap (lower) Screw.....
*42059	—	Needle Bar Lever Connecting Rod Cap (upper).....
896e	8507	Needle Bar Lever Connecting Rod Cap (upper) Screw.....
42077	8516	Needle Bar Lever Connecting Rod Guide
171j	8512	" " " " " "
		Screw.....
64848	8512	Needle Bar Lever Connecting Rod Oil Cup.....
64849	8501	Needle Bar Lever Hinge Stud.....
64836	8515	" " " " " Collar with two 1259c.....
1259c	8515	Needle Bar Lever Hinge Stud Collar Set Screw.....
1036c	8507	Needle Bar Lever Hinge Stud Set Screw.
64850	8515	" " Washer.....
50165e	8515	" " " Screw.....
1737c	8524	" Clamping Nut.....
64937	8516	Plait Guide (lower).....
68525	—	" " (stationary) Nos. 3224f and 68526.....
68526	9307	Plait Guide (stationary) Bracket with 735c.....
32244	8516	Plait Guide (stationary) Rod.....
735c	8516	" " " " Set Screw..
32237	8516	" " (upper).....
32039	8524	" " " Friction Washer....
1359j	8524	" " " Hinge Screw.....

NO.	PLATE	NAME
64953	9302	Plait Guide (upper) Holder with 54705...
68518	—	" " " " 64953 with 208e, 240j, 32237 and 64958.....
32239	8516	Plait Guide (upper) Lock Stud.....
32240	8516	" " " " " Spring....
50117e	8516	" " " " " Screw
208e	8507	" " " Screw.....
54705	8516	" " " Steady Pin.....
64888	8516	" " Block.....
1485j	8516	" " " Screw.....
64955	9302	" " Braid Retaining Finger (medium).....
64956	9302	Plait Guide Braid Retaining Finger (narrow).....
64957	9302	Plait Guide Braid Retaining Finger (wide).....
64958	9302	Plait Guide Braid Retaining Finger Cush- ion Spring.....
240j	8518	Plait Guide Braid Retaining Finger Cush- ion Spring Screw.....
64959	9302	Plait Guide Braid Retaining Finger Holder
64960	9302	" " " " " "
		Lock Spring.....
240j	8518	Plait Guide Braid Retaining Finger Holder Lock Spring Screw.....
64961	8524	Plait Guide Braid Retaining Finger Locking Lever.....
64962	8524	Plait Guide Braid Retaining Finger Locking Lever 64961 with 19045 and 64963....
19045	8524	Plait Guide Braid Retaining Finger Locking Lever Handle.....
64963	8524	Plait Guide Braid Retaining Finger Locking Lever Stud.....
102j	8524	Plait Guide Braid Retaining Finger Locking Lever Stud Screw.....
64954	—	Plait Guide complete, Nos. 102j, 240j, 1359j, 32039, 32239, 32240, 50117e, 64937, 64959, 64960, 64962 and 68518..
19020	8512	Plait Guide Friction Washer.....
19055	8516	" " Regulating Pinion.....
1004f	8516	" " " " Screw....
1005f	8516	" " " " Screw.....
32170	8517	Presser Bar.....
64909	8517	" " Guide Bracket with 1454f, 1700j, 50203f and 50364c.....
50203f	8515	Presser Bar Guide Bracket Adjusting Screw.....

NO.	PLATE	NAME
1454F	8517	Presser Bar Guide Bracket Clamping Screw.....
42007	8517	Presser Bar Guide Bracket Guide.....
457C	8517	" " " " " Set Screw
64964	9307	" " Lifter.....
32235	8517	" " " Hinge Stud.....
452C	8507	" " " " " Set Screw..
51807	8517	" " Roller and Screw Stud.....
64853	8504	" " Spring (flat).....
54722	8524	" " " Pin.....
32175	8517	" " " Stud.....
68520	9307	" " Tipper.....
68524	—	Presser Bar Tipper complete, Nos. 229J and 68520 to 68522.....
50364C	8517	Presser Bar Tipper Adjusting Screw.....
1700J	8517	" " " " " Nut..
68521	9307	" " " Hinge Stud.....
742F	9303	" " " " " Screw....
68522	9307	" " " Retaining Spring.....
229J	9307	" " " " " Screw
704J	8517	" Foot Adjusting Screw.....
32210	8517	" " " " Washer....
64966	9303	" " Extension for 64967.....
68504	9303	" " " " 68505.....
64987	9303	" " " " 64988.....
64965	9303	" " Plate.....
64644	9303	" " " Adjusting Lever with 19045 and 19046.....
5480	9303	Presser Foot Plate Adjusting Lever Friction Washer.....
19045	8524	Presser Foot Plate Adjusting Lever Handle
19046	9303	" " " " " Pin....
51047C	9303	" " " " " Screw..
32212	9303	" " Shank.....
64967	—	Presser Foot (adjustable) complete, for $\frac{1}{8}$ in. throw, Nos. 704J, 5480, 32210, 32212, 51047c, 64644, 64965 and 64966.....
68505	—	Presser Foot (adjustable) complete, for $\frac{5}{32}$ in. and $\frac{1}{4}$ in. throw, Nos. 704J, 5480, 32210, 32212, 51047c, 64644, 64965 and 68504.....
64988	—	Presser Foot (adjustable) complete, for $\frac{3}{8}$ in. throw, Nos. 704J, 5480, 32210, 32212, 51047c, 64644, 64965 and 64987.....
64981	9303	Presser Foot Cord Guide.....
1161J	9303	" " " " Screw.....
64982	9303	" " Plate.....

NO.	PLATE	NAME
64983	—	Presser Foot (adjustable) complete, for cording, Nos. 704J, 1161J, 32210, 32212, 64981 and 64982.....
64984	9303	Presser Foot Braid Guide.....
1161J	9303	" " " " Screw.....
64985	9303	" " Plate.....
64986	—	Presser Foot (adjustable) complete, for soutache braid, Nos. 704J, 1161J, 32210, 32212, 64984 and 64985.....
50161C	8517	Presser Foot Screw.....
21202	8524	" " " Washer (lower).....
19047	8517	" " " " (upper).....
50132W	8507	Pressure Regulating Thumb Screw.....
1543W	8507	" " " " " Lock Nut.....
2102	8517	Tension Disc.....
64933	8517	" Regulating Plate and Thread Eyelet.....
1560C	8518	Tension Regulating Thumb Nut.....
64934	8517	" Regulator.....
64935	8517	" " Friction Spring.....
50261C	8518	" Screw Stud.....
64881	—	" " " 50261c with 1560c...
54738	8518	" Spring.....
19068	8518	Thread Controller Bracket.....
330J	8507	" " " Screw.....
64941	8518	" " Guide Plate with 68517.....
68517	9307	" " " Stud.....
64856	8504	" " Releasing Rod.....
59042	8518	" " Spring.....
22430	8518	" Eyelet (top of arm).....
64943	8521	" Eyelet.....
50090J	8518	" " Set Screw.....
64968	9304	Throat Plate (back) with 39272.....
1319F	8507	" " " Screw.....
68527	9309	" " (front) with two 39272.....
68528	—	" " " 68527 with 990J, 64972 and 68530.....
68529	—	Throat Plate (front) 68528 with 111J, 1240c, 64905 and 64906.....
997D	8512	Throat Plate (front) Screw.....
64972	9304	" " Braid Dividing Finger with 64978.....
68530	9309	Throat Plate Braid Dividing Finger Hinge Spring.....
990J	9307	Throat Plate Braid Dividing Finger Hinge Spring Screw.....

From the Library of: Harbord Needle Co.

NO.	PLATE	NAME
*64978	---	Throat Plate Braid Dividing Finger Hinge Stud.....
64974	9304	Throat Plate Needle Hole Strip, for $\frac{1}{8}$ in., $\frac{5}{32}$ in. and $\frac{11}{64}$ in. throw.....
64919	9304	Throat Plate Needle Hole Strip, for $\frac{3}{16}$ in. throw.....
64975	9304	Throat Plate Needle Hole Strip Guide
64976	---	“ “ “ “ “ “ 64975 with 64977 and two 8505, for $\frac{1}{8}$ in. throw.....
68507	---	Throat Plate Needle Hole Strip Guide 64975 with 68506 and two 8505, for $\frac{5}{32}$ in. throw.....
68533	---	Throat Plate Needle Hole Strip Guide 64975 with 68532 and two 8505, for $\frac{11}{64}$ in. throw.....
64989	---	Throat Plate Needle Hole Strip Guide 64975 with 64921 and two 8505, for $\frac{3}{16}$ in. throw.....
64977	9304	Throat Plate Needle Hole Strip Guide Extension for 64976.....
68506	9304	Throat Plate Needle Hole Strip Guide Extension for 68507.....
64921	9304	Throat Plate Needle Hole Strip Guide Extension for 64989.....
68532	9309	Throat Plate Needle Hole Strip Guide Extension for 68533.....
8505	8518	Throat Plate Needle Hole Strip Guide Extension Rivet.....
1094f	8518	Throat Plate Needle Hole Strip Guide Screw.....
193f	8518	Throat Plate Needle Hole Strip Screw....
39272	8518	“ “ Position Pin.....

FITTINGS FOR $\frac{1}{8}$ INCH THROW

MACHINE IS REGULARLY FITTED WITH THE FOLLOWING COMBINATION OF PARTS UNLESS OTHERWISE SPECIFIED ON ORDER.

NO.	PLATE	NAME
64954	---	Plait Guide complete, Nos. 102J, 240J, 1359J, 32039, 32239, 32240, 50117E, 64937, 64959, 64960, 64962 and 68518..
64967	---	Presser Foot (adjustable) complete, Nos. 704J, 5480, 32210, 32212, 51047c, 64644, 64965 and 64966.....
64974	9304	Throat Plate Needle Hole Strip.....

NO.	PLATE	NAME
64976	---	Throat Plate Needle Hole Strip Guide 64975 with 64977 and two 8505.....
64977	9304	Throat Plate Needle Hole Strip Guide Extension.....

SPECIAL FITTINGS

COMBINATIONS OF PARTS, OTHER THAN REGULAR, FOR SPECIAL WORK

FOR $\frac{5}{32}$ IN. THROW

NO.	PLATE	NAME
64954	---	Plait Guide complete, Nos. 102J, 240J, 1359J, 32039, 32239, 32240, 50117E, 64937, 64959, 64960, 64962 and 68518..
68505	---	Presser Foot (adjustable) complete, Nos. 704J, 5480, 32210, 32212, 51047c, 64644, 64965 and 68504.....
64974	9304	Throat Plate Needle Hole Strip.....
68507	---	“ “ “ “ “ Guide 64975 with 68506 and two 8505.....
68506	9304	Throat Plate Needle Hole Strip Guide Extension.....
FOR $\frac{11}{64}$ IN. THROW		
64954	---	Plait Guide complete, Nos. 102J, 240J, 1359J, 32039, 32239, 32240, 50117E, 64937, 64959, 64960, 64962 and 68518..
68505	---	Presser Foot (adjustable) complete, Nos. 704J, 5480, 32210, 32212, 51047c, 64644, 64965 and 68504.....
64974	9304	Throat Plate Needle Hole Strip.....
68533	---	“ “ “ “ “ Guide 64975 with 68532 and two 8505.....
68532	9309	Throat Plate Needle Hole Strip Guide Extension.....

FOR $\frac{3}{16}$ IN. THROW

64954	---	Plait Guide complete, Nos. 102J, 240J, 1359J, 32039, 32239, 32240, 50117E, 64937, 64959, 64960, 64962 and 68518..
64988	---	Presser Foot (adjustable) complete, Nos. 704J, 5480, 32210, 32212, 51047c, 64644, 64965 and 64987.....
64919	9304	Throat Plate Needle Hole Strip.....
64989	---	“ “ “ “ “ Guide 64975 with 64921 and two 8505.....
64921	9304	Throat Plate Needle Hole Strip Guide Extension.....

FOR LAPPING BRAID

NO.	PLATE	NAME
64886	9302	Plait Guide (lower).....
32237	8516	“ “ (upper).....
32262	9302	“ “ “ Friction Washer.....
32238	8516	“ “ “ Holder with 54705....
	102J 8524	“ “ “ Hinge Screw.....
64887	—	Plait Guide complete, Nos. 102J, 208E, 1359J, 32039, 32237, 32239, 32240, 50117E, 64886, 64953, 61958 to 64960, 64962 and two 240J.....
19056	9302	Plait Guide (inside edge) Nos. 19059 and 19060.....
19059	—	Plait Guide (inside edge) Plate.....
19060	—	“ “ “ “ Rod.....
68540	9308	Presser Foot Guide (No. 1) (narrow) for 68541.....
68509	9308	Presser Foot Guide (No. 2) for 68510....
68538	9308	“ “ “ (No. 3) “ 68539....
68534	9308	“ “ “ (No. 4) “ 68535....
68536	9308	“ “ “ (No. 5) “ 68537....
19043	9303	“ “ “ Adjusting Lever with 19045 and 19046.....
19020	8512	Presser Foot Guide Adjusting Lever Friction Washer.....
19045	8524	Presser Foot Guide Adjusting Lever Handle.....
19046	9303	Presser Foot Guide Adjusting Lever Pin.....
1003c	9303	Presser Foot Guide Adjusting Lever Thumb Screw.....
32211	9303	Presser Foot Plate.....
32212	9303	“ “ Shank.....
32213	—	“ “ (adjustable) Nos. 704J, and 32210 to 32212.....
68510	—	Presser Foot (adjustable) complete, for lapping cotton braid, Nos. 1003c, 19020, 19043, 32213 and 68509.....
68535	—	Presser Foot (adjustable) for lapping canton braid, Nos. 1003c, 19020, 19043, 32213 and 68534.....
68537	—	Presser Foot (adjustable) complete, for lapping coarse braid, Nos. 1003c, 19020, 19043, 32213 and 68536.....
68539	—	Presser Foot (adjustable) complete, for lapping milan braid, Nos. 1003c, 19020, 19043, 32213 and 68538.....

NO.	PLATE	NAME
68541	—	Presser Foot (narrow, adjustable) com- plete, for lapping pyroxlin braid, Nos. 1003c, 19020, 19043, 32213 and 68540..
64974	9304	Throat Plate Needle Hole Strip.....
64975	9304	“ “ “ “ “ Guide.....
64976	—	“ “ “ “ “ “ 64975 with 64977 and two 8505, for 1/8 in. throw
64977	9304	Throat Plate Needle Hole Strip Guide Extension.....
8505	8518	Throat Plate Needle Hole Strip Guide Extension Rivet.....

MACHINE BASE

NO.	PLATE	NAME
64902	8522	Machine Base with three wood screws 1 1/2 in. No. 12 and four each 935E, 42088 and 66707.....
42088	8507	Machine Cushion (felt).....
	935E 8507	“ “ Screw.....
66707	8524	“ “ “ Washer.....

ACCESSORIES

NO.	PLATE	NAME
1408E	9306	Machine Thumb Screw.....
14063	9306	“ “ “ Spring.....
9842	8507	“ “ “ Washer.....
120344	8520	Oiler (copper plated) with 120345.....
120345	8520	“ Spout, 5 in. long.....
120440	8520	Screw Driver (large).....
26485	8520	“ “ (small).....
8908	8520	Wrench for 1520.....
68547	8520	“ “ 1027 and 1737.....

FOOT LIFTER PARTS

NO.	PLATE	NAME
6439	—	Chain, 36 in. to 45 in., with 56864 and 56865.....
4879	8521	Chain Connecting Link.....

NOTE: When ordering No. 6439, state length required.

from the library of: Diamond Needle Corp.

NO.	PLATE	NAME
56864	8518	Chain Hook (large).....
56865	8507	“ “ (small).....
64865	8504	Lifting Lever.....
788 _D	8507	“ “ Hinge Screw.....
64930	8521	“ “ Link.....
1250c	8507	“ “ “ Guide Screw.....
1184 _D	8507	“ “ “ Hinge Screw.....
19081	8507	“ “ Spring.....
59051	8522	Treadle.....
7585	8521	“ Shaft.....
14357	8522	“ Stand.....
59074	8522	Treadle complete, Nos. 4879, 7585, 14357, 59051 and two wood screws 1¼ in. No.12
64947	—	Foot Lifter complete, Nos. 788 _D , 1184 _D , 1250c, 6439, 19081, 59074, 64865 and 64930.....

KNEE LIFTER PARTS

NO.	PLATE	NAME
59055	—	Chain, length 18 in., with two 56865.....
56865	8507	“ Hook.....
64865	8504	Lifting Lever.....
788 _D	8507	“ “ Hinge Screw.....
64930	8521	“ “ Link.....
1250c	8507	“ “ “ Guide Screw.....
1184 _D	8507	“ “ “ Hinge Screw.....
19081	8507	“ “ Spring.....
7124	8522	Rock Shaft.....
2764	8522	“ “ Hanger (back) with two wood screws 1 in. No. 10.....
16128	8522	Rock Shaft Hanger (front) with two wood screws 1 in. No. 10.....
16646	8522	Rock Shaft Knee Arm.....
16647	—	Rock Shaft Knee Arm complete, Nos. 2766, 2767 and 16646.....
2766	8522	Rock Shaft Knee Arm Hub with 356c....
356c	8507	“ “ “ “ “ Set Screw ...
2767	8522	“ “ “ Plate with 356c.....
356c	8507	“ “ “ “ Set Screw.....
6337	8522	“ “ Lifting Bracket with two 356c
6338	8522	“ “ “ “ Hook.....
356c	8507	“ “ “ “ “ Set Screw
356c	8507	“ “ “ “ “ Set Screw ...
32134	8522	“ “ Spring.....
2770	8522	“ “ “ Adjusting Dog with 356c.....

NO.	PLATE	NAME
356c	8507	Rock Shaft Spring Adjusting Dog Set Screw.....
2770	8522	Rock Shaft Stop Dog with 356c.....
356c	8507	“ “ “ “ Set Screw.....
32135	8522	Rock Shaft complete, Nos. 2764, 6337, 6338, 7124, 16128, 16647, 32134 and three 2770.....
64948	—	Knee Lifter complete, Nos. 788 _D , 1184 _D , 1250c, 19081, 32135, 59055, 64865 and 64930.....

TABLE SUPPORT PARTS

NO.	PLATE	NAME
41044	8510	Base with three wood screws 1¼ in. No. 14
41045	8510	Top with two wood screws 1¼ in. No. 14..
41046	8510	Tube.....
1726 _P	9306	“ Lock Nut.....
41047	—	Table Support Tube complete, Nos. 1726 _P and 41044 to 41046.....

THREAD UNWINDER

FOR ONE SPOOL

NO.	PLATE	NAME
225389	8523	Spool Rest with 201018c.....
225388	8523	“ “ Rod.....
200383c	8518	“ “ “ Set Screw.....
201018c	8518	“ “ Set Screw.....
202490	8523	“ Stand with 200383c.....
225391	8523	Thread Guide.....
201696 _J	8518	“ “ Lock Nut.....
225392	8523	“ “ Rod with 208 _E and 225393
208 _E	8507	“ “ Screw.....
225393	8518	“ “ “ Washer.....
225394	8523	Thread Unwinder complete, Nos. 201696 _J , 202490, 225388, 225389, 225391, 225392 and three wood screws 7/8 in. No. 12...
27739	8520	Thread Cone (wood) for large cones.....
225390	8520	“ “ Holder, for inverted cones..

NOTE: Nos. 27739 and 225390 are used with, but
not included in 225394.

PLATE 8504—ONE-HALF SIZE

64865 64853 64837 64846 64841

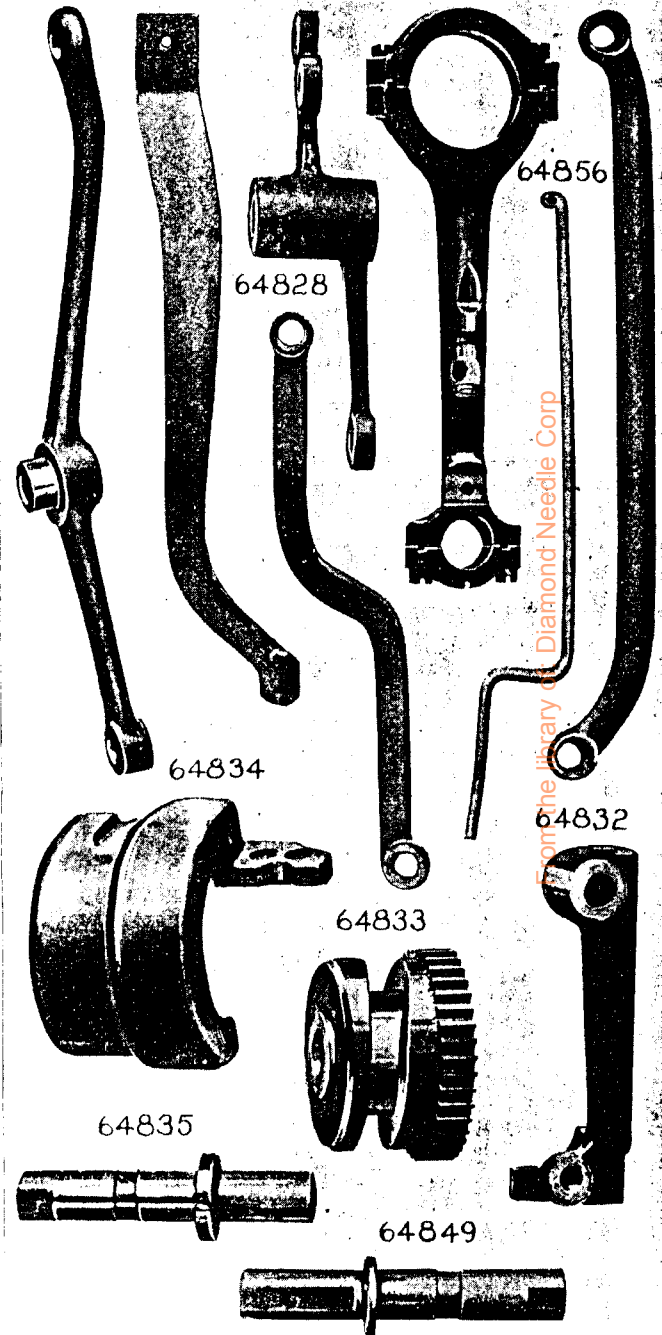

PLATE 8507—FULL SIZE

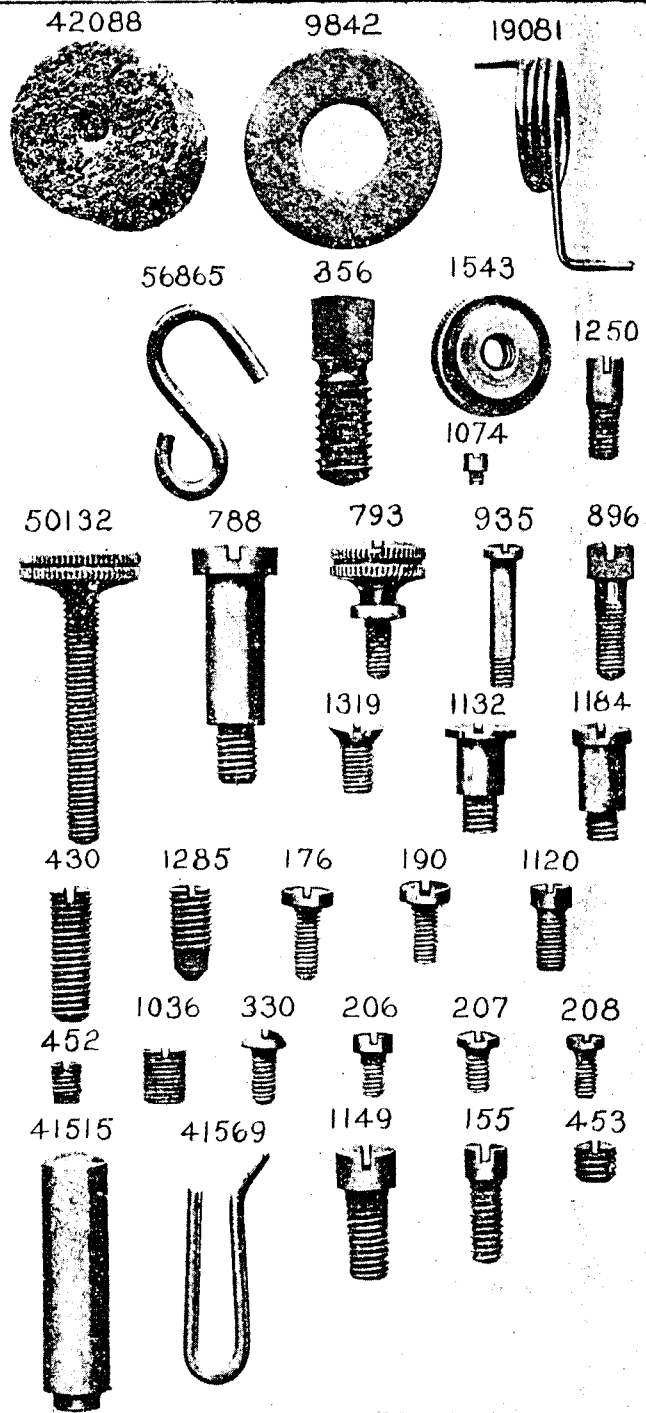
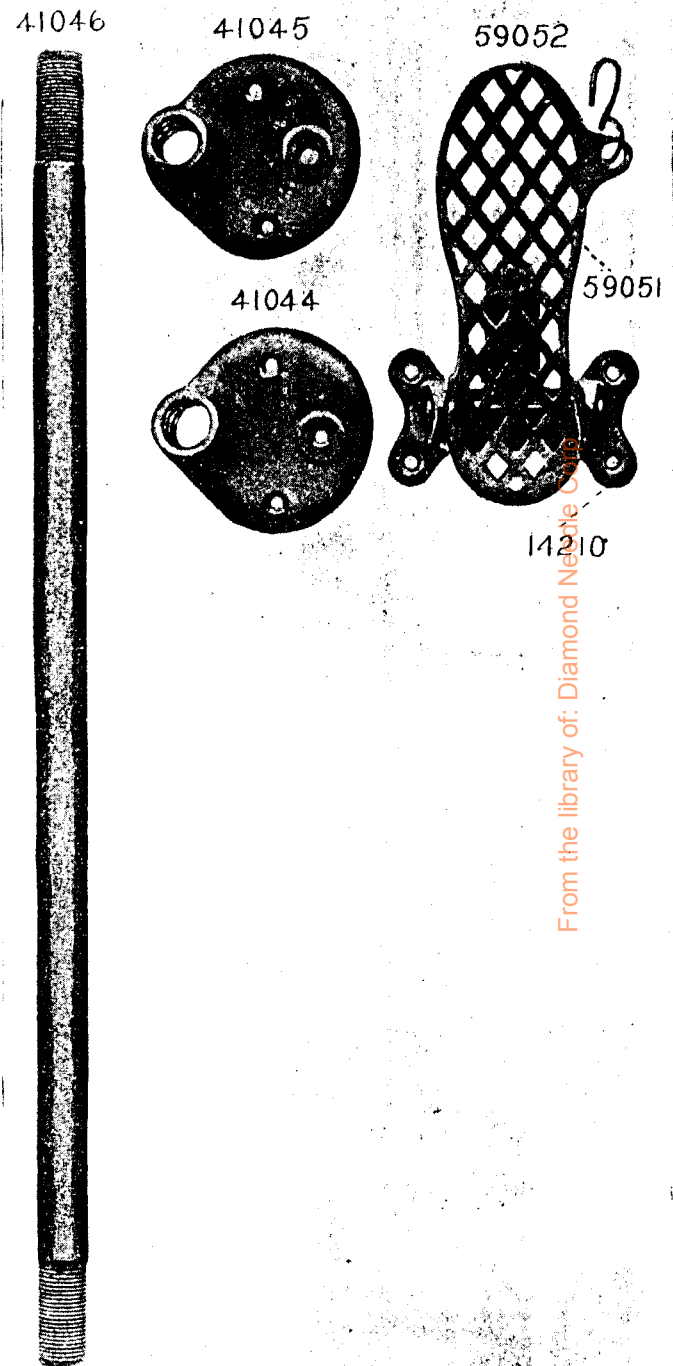

PLATE 8510—ONE-FOURTH SIZE



From the library of: Diamond Needle Co.

PLATE 8511—ONE-HALF SIZE

64802 64816 59211

34461

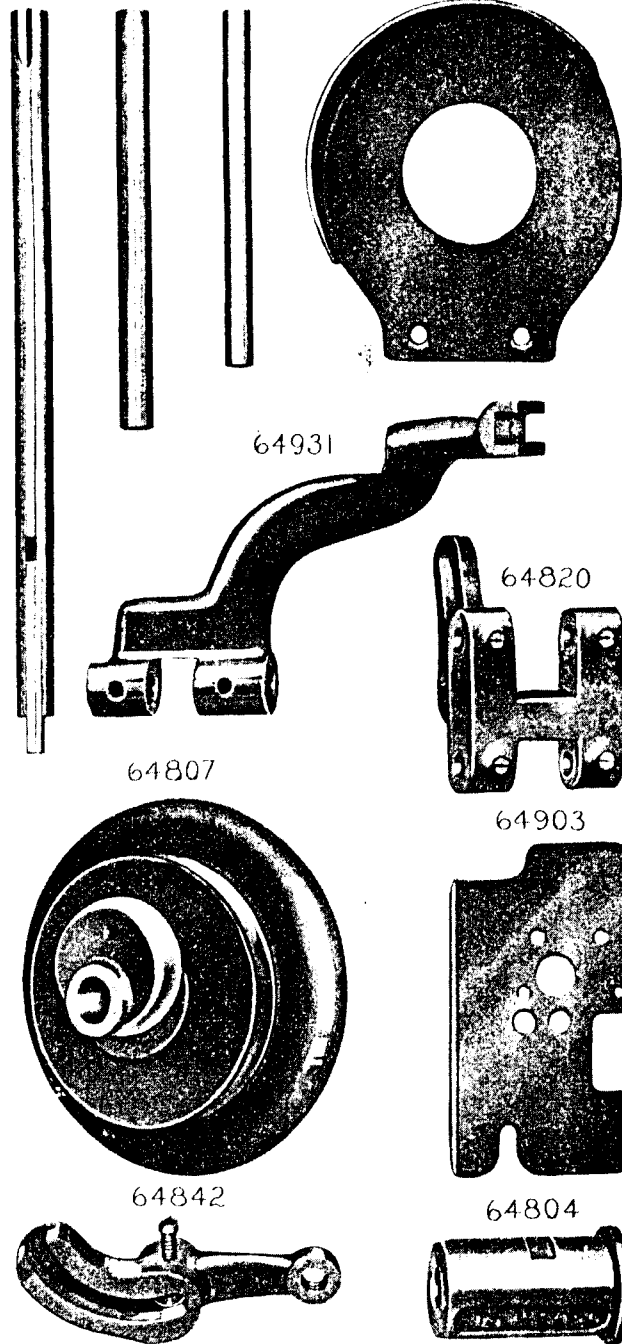

PLATE 8512—FULL SIZE

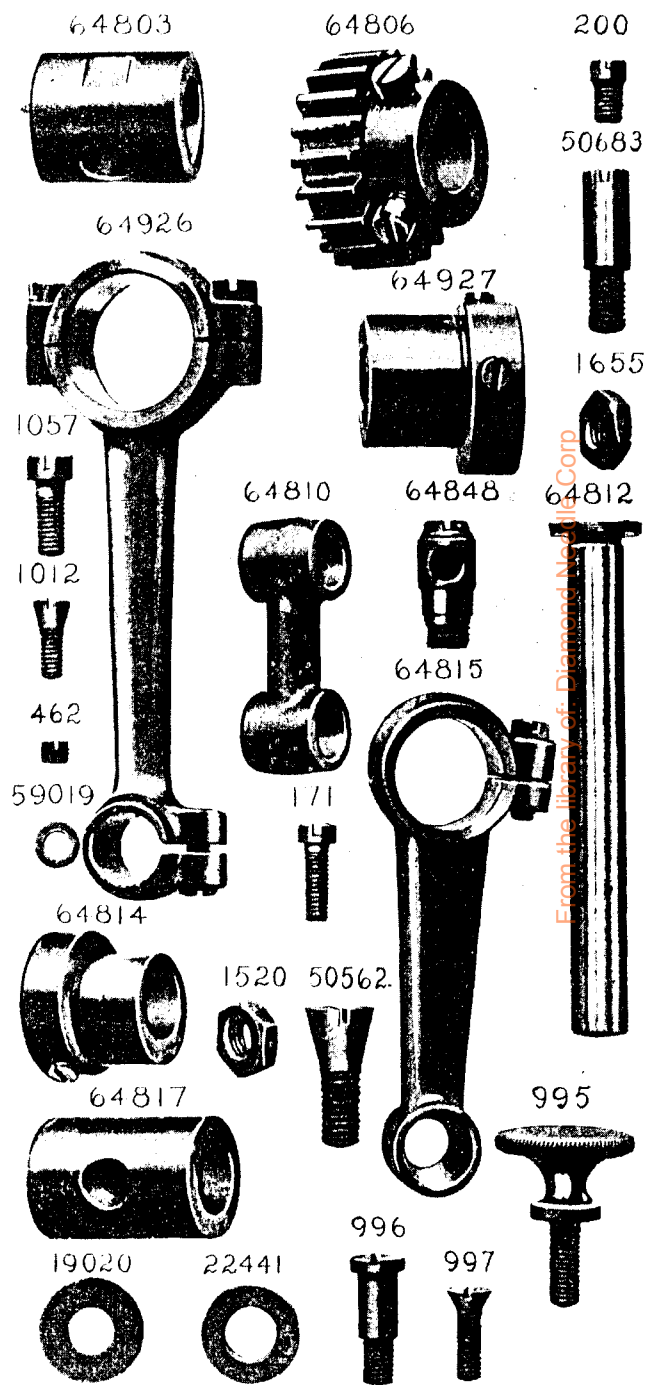

PLATE 8514—FULL SIZE

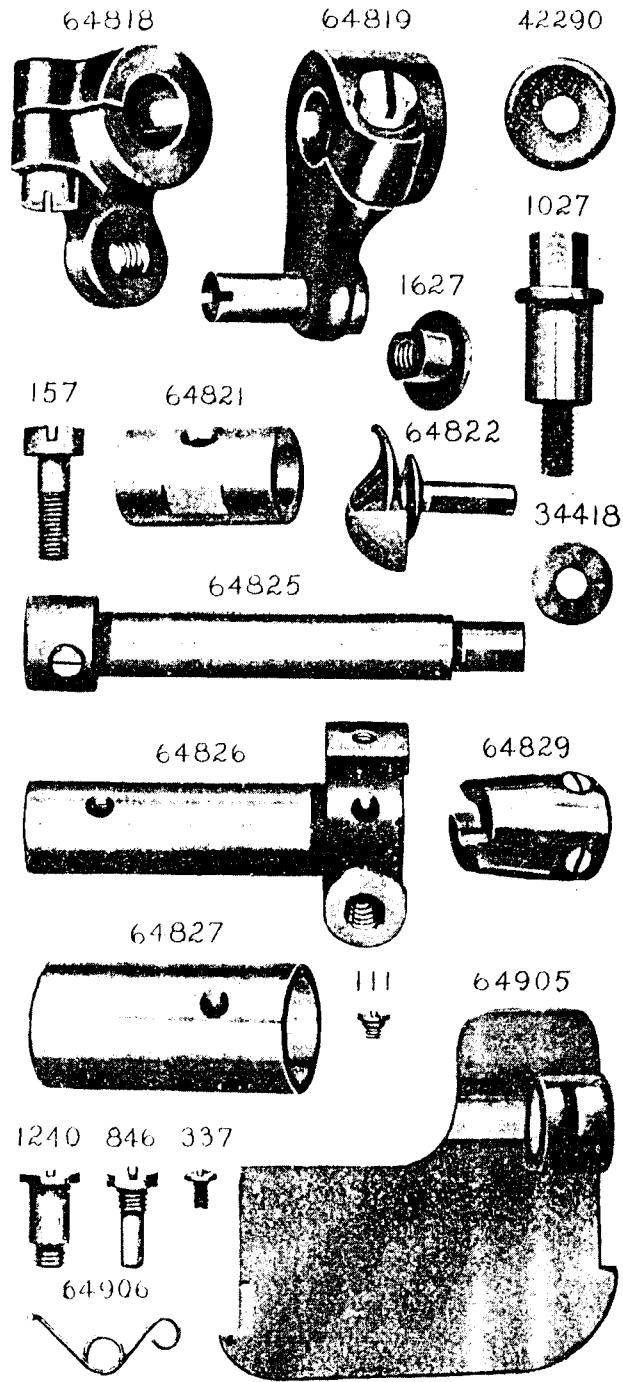

PLATE 8515—FULL SIZE

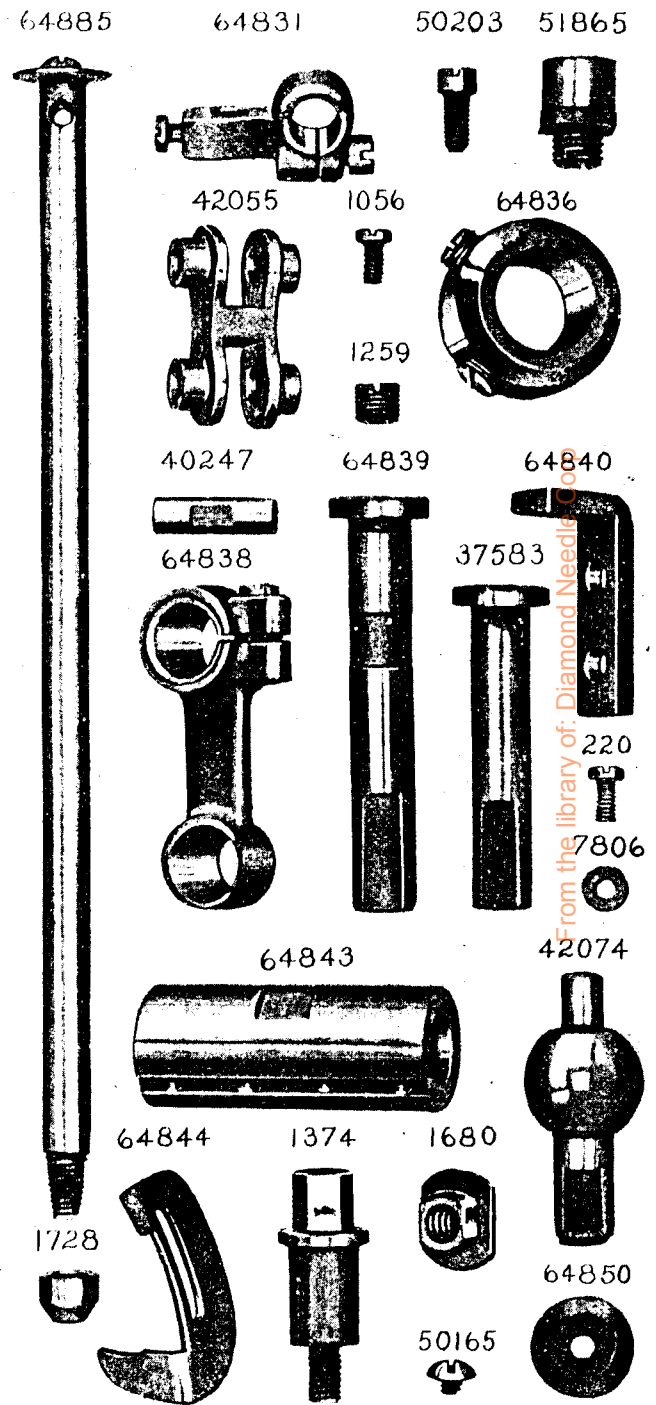

PLATE 8516—FULL SIZE

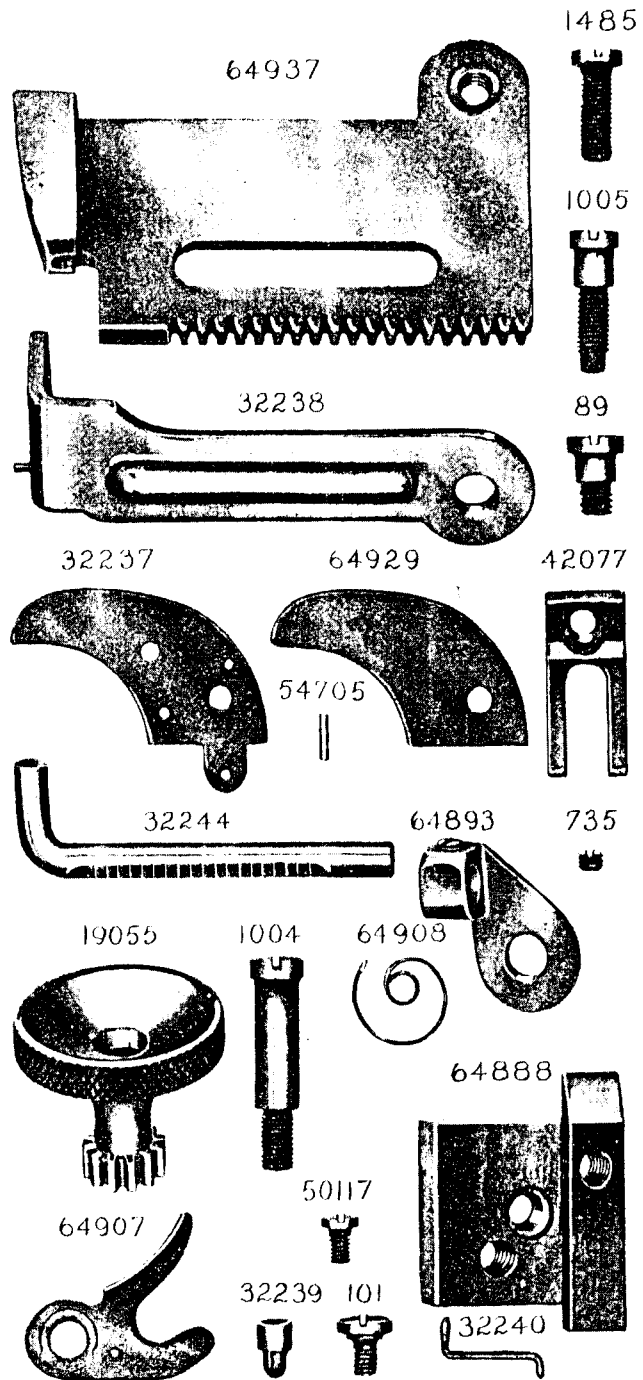

PLATE 8517—FULL SIZE

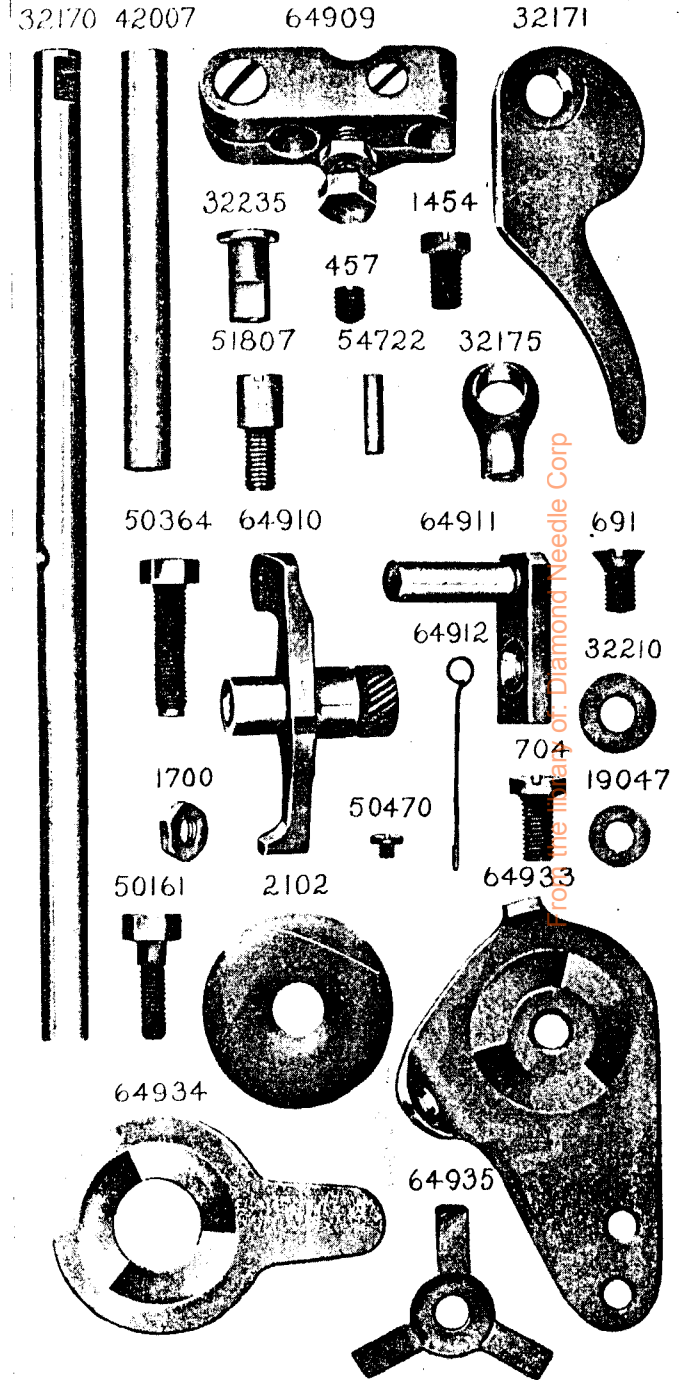

PLATE 8518—FULL SIZE

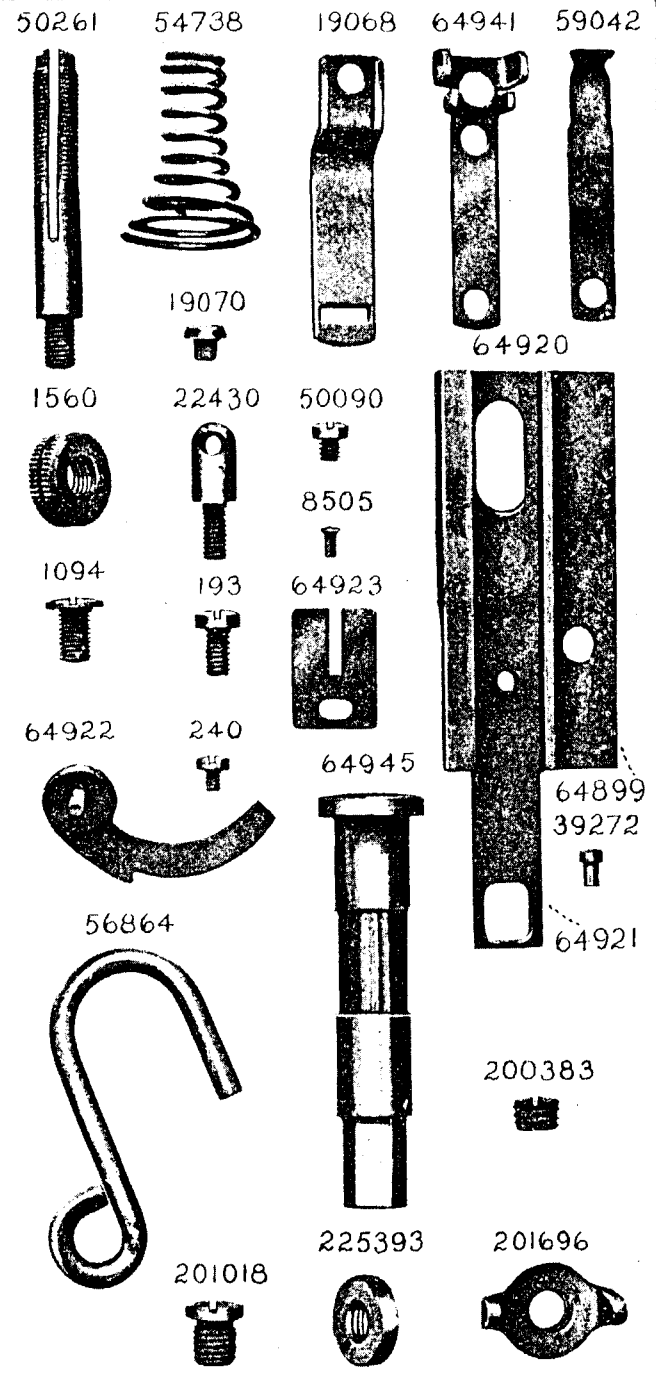

PLATE 8520—ONE-HALF SIZE

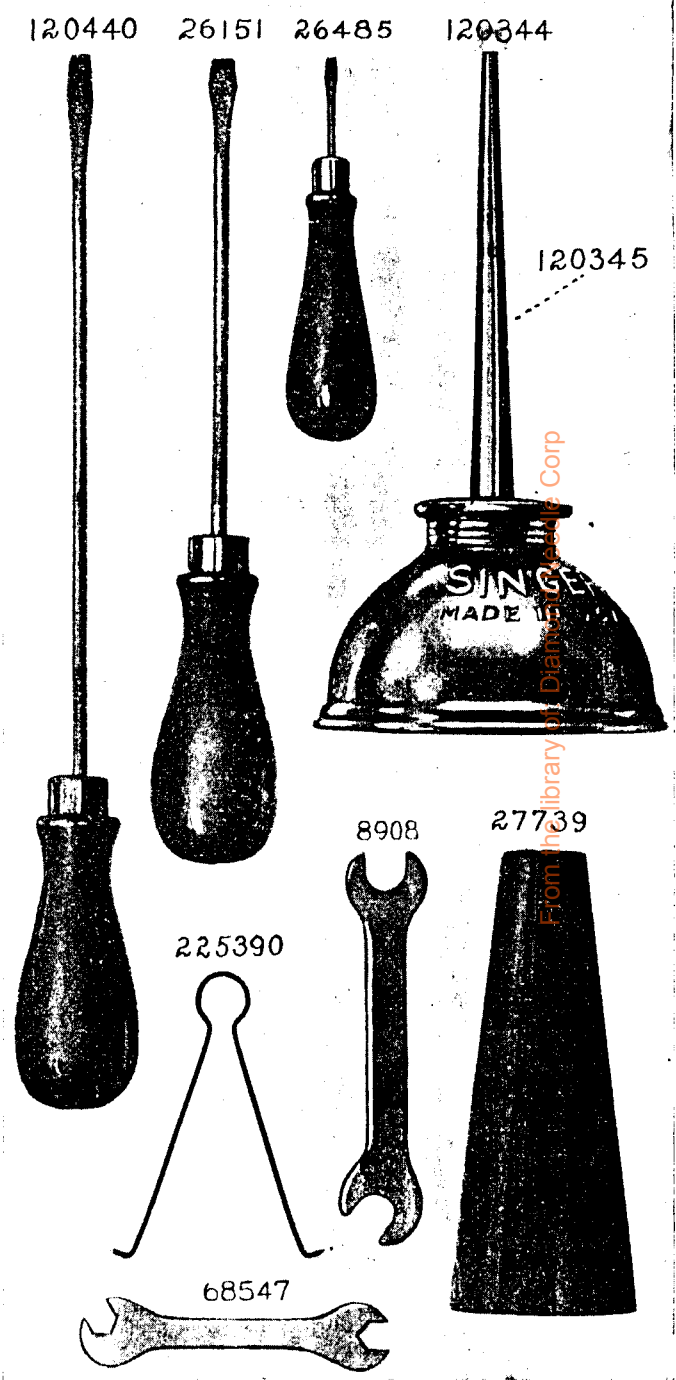
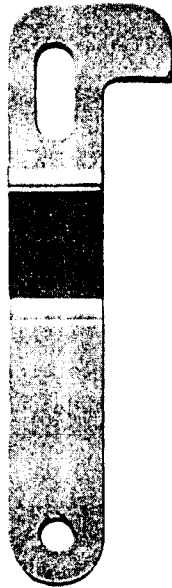

PLATE 8521—FULL SIZE

7585



64930



64946



64942

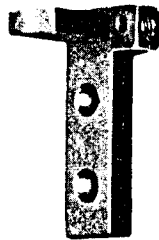

64943



4879

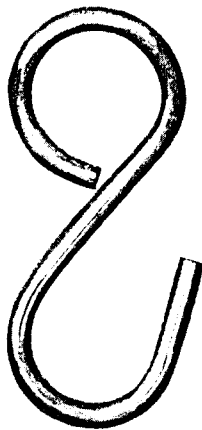

PLATE 8522—ONE-FOURTH SIZE

2764



16128



32135

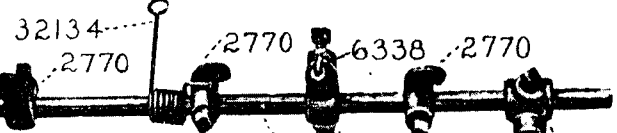

32134
2770

2770

6338

2770

59074

7124

6337

2766

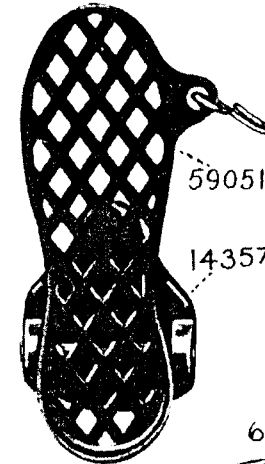

16646

59051

14357

2767



64845



64902

64883

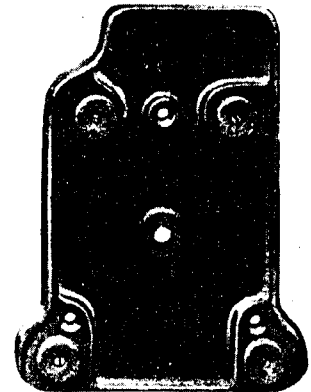
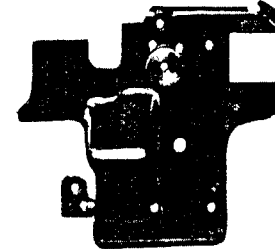

From the library of Diamond Needle Corp

PLATE 8523—ONE-SIXTH SIZE

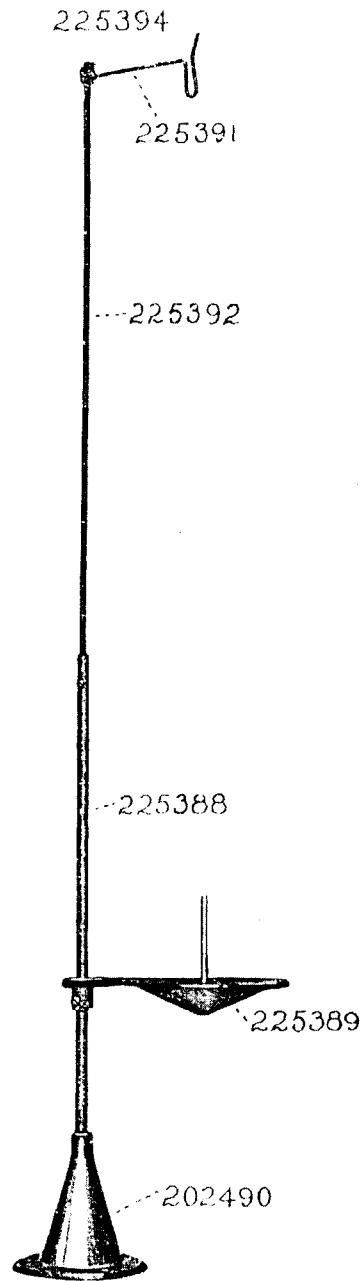

PLATE 8524—FULL SIZE

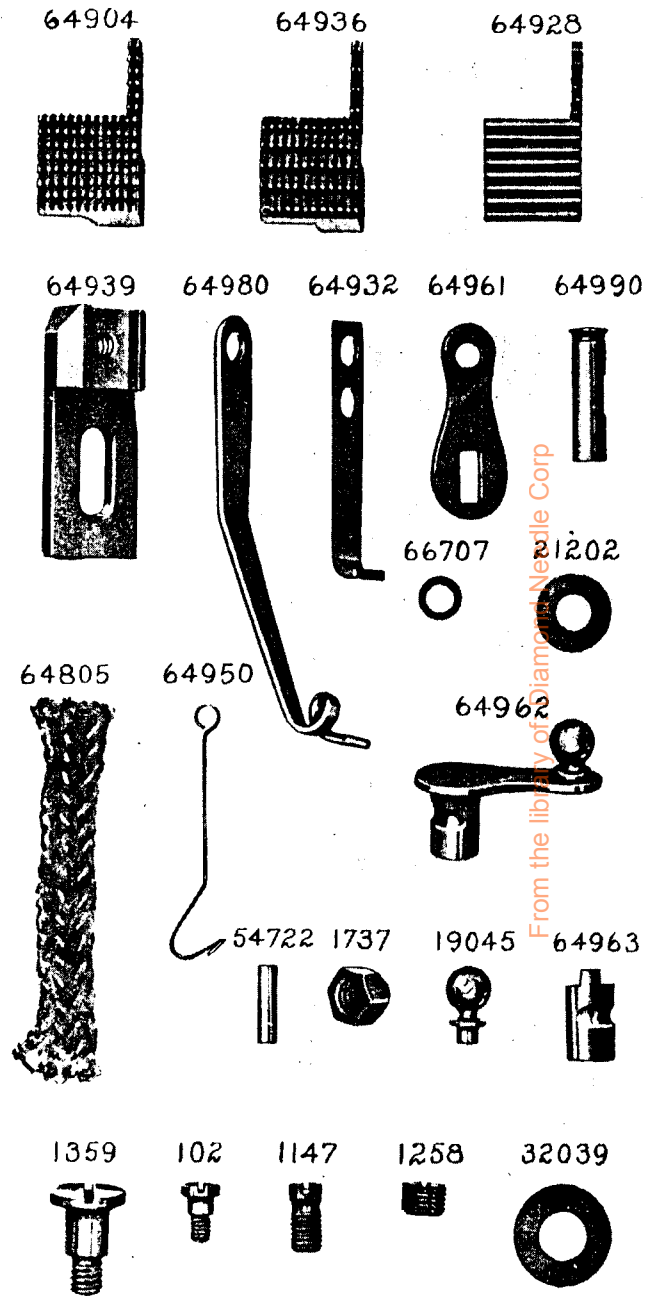

PLATE 9301—FULL SIZE

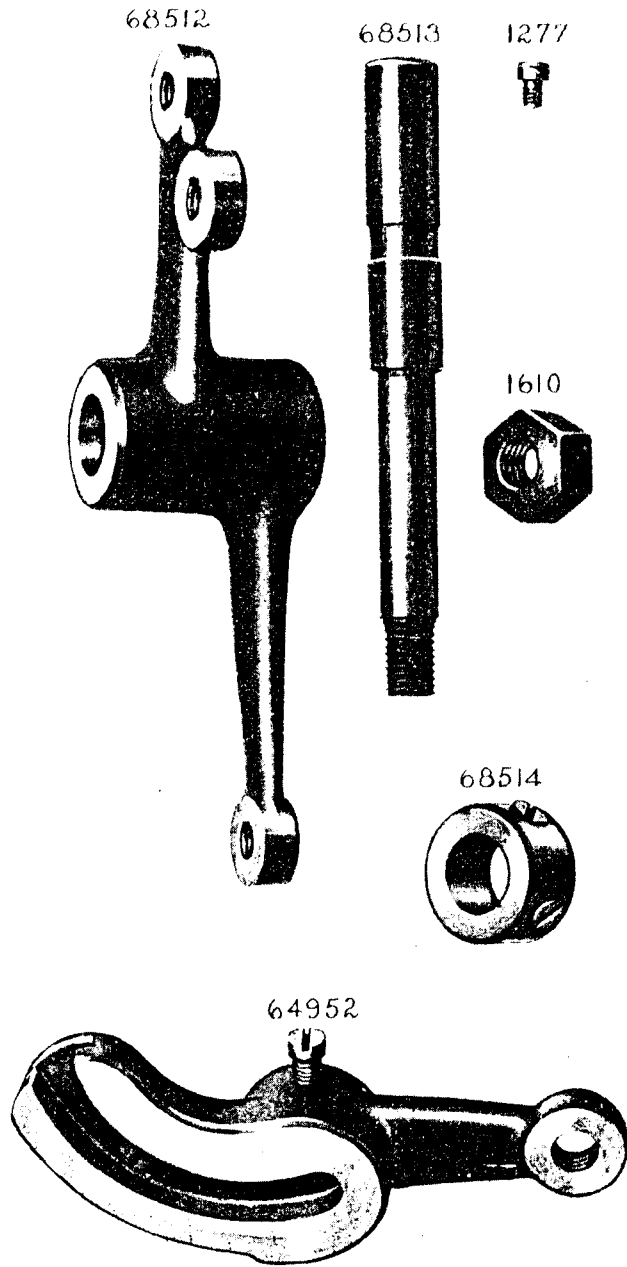

PLATE 9302—FULL SIZE

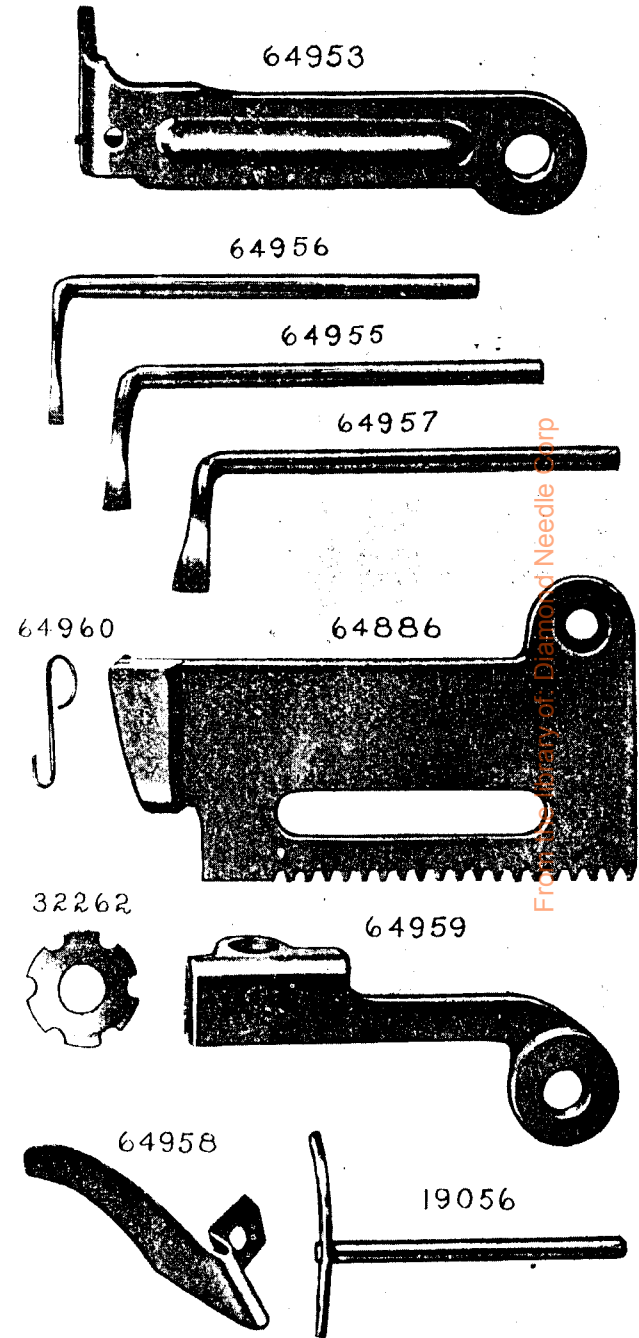

PLATE 9303—FULL SIZE

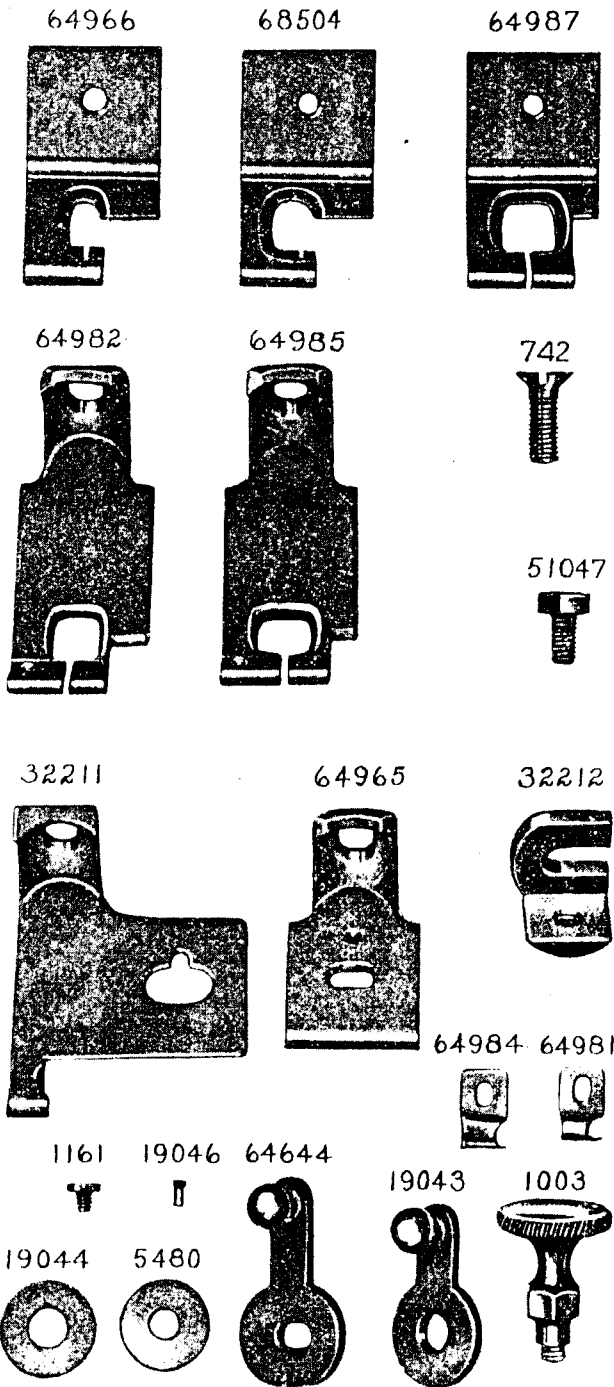
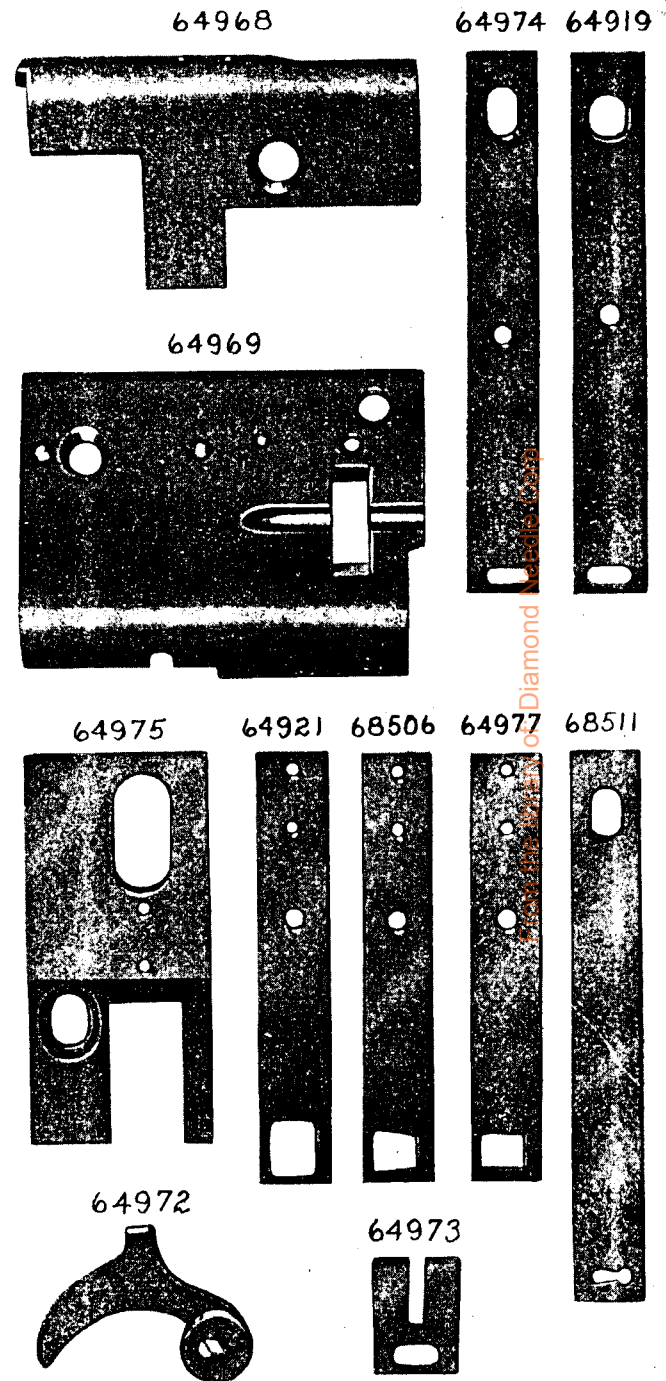

PLATE 9304—FULL SIZE



©Diamond

PLATE 9303—FULL SIZE

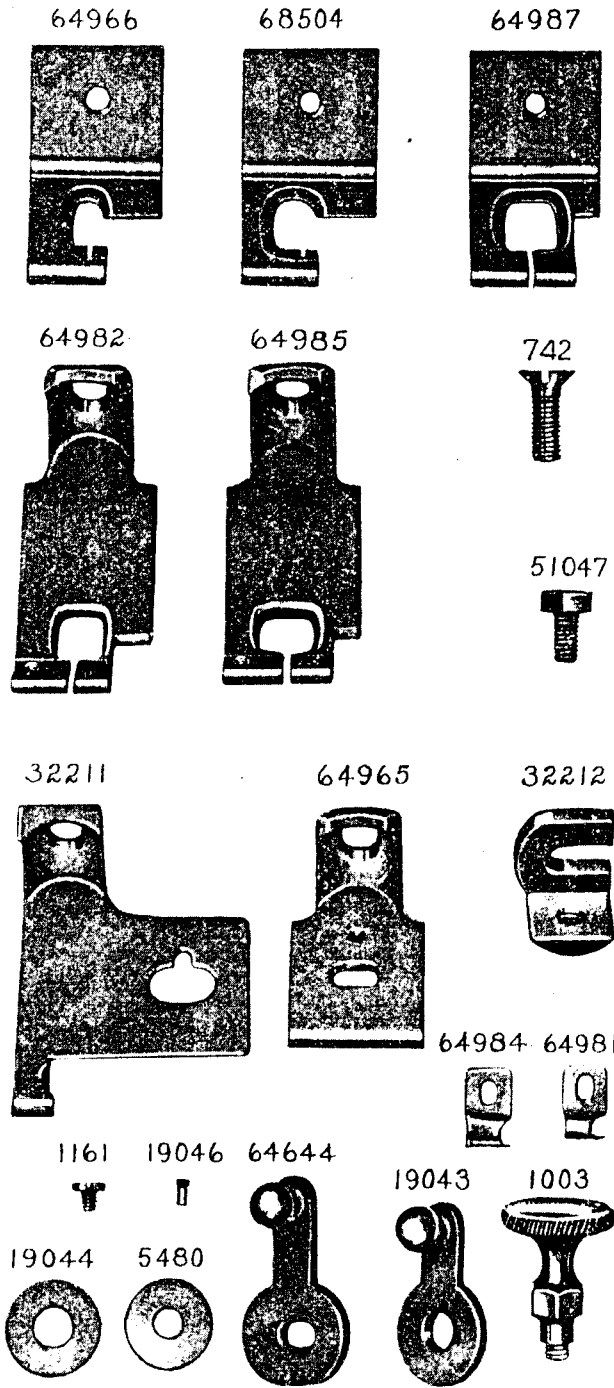

PLATE 9304—FULL SIZE

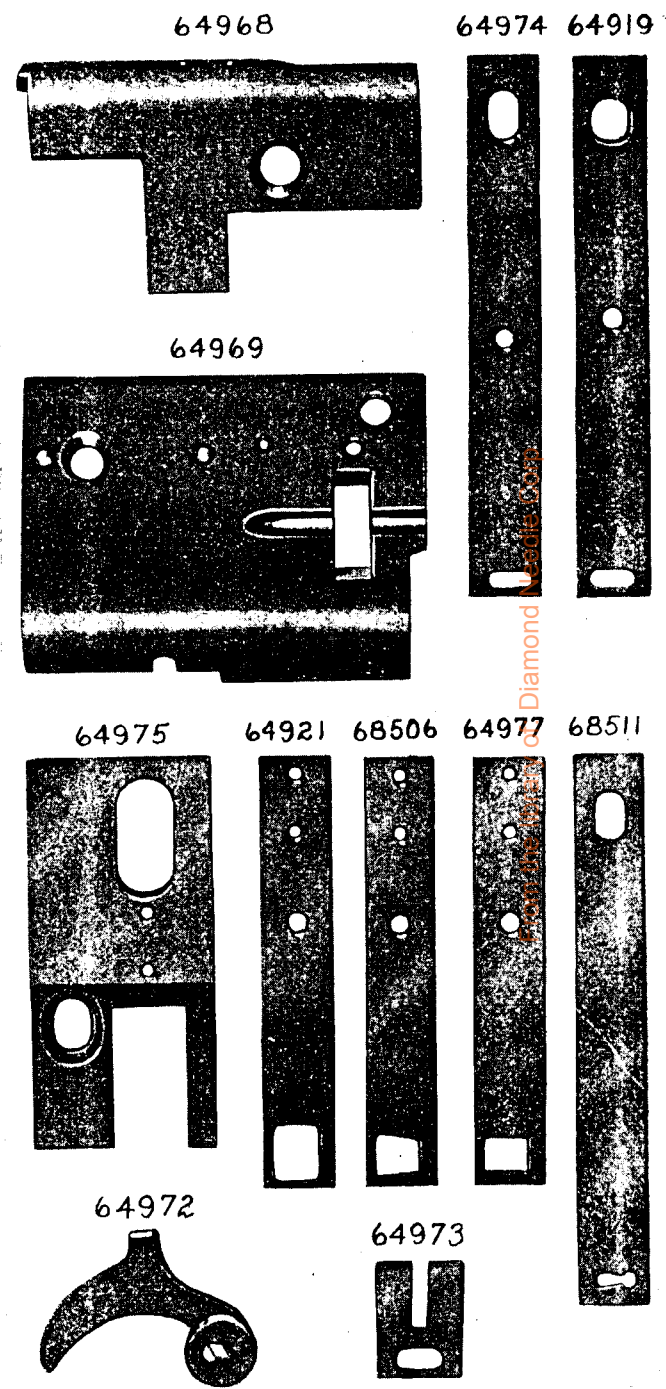

PLATE 9306—FULL SIZE

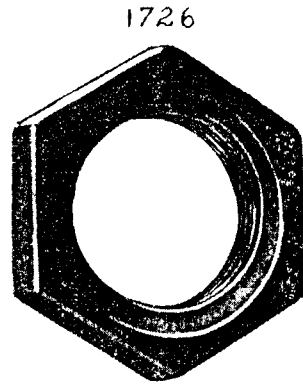
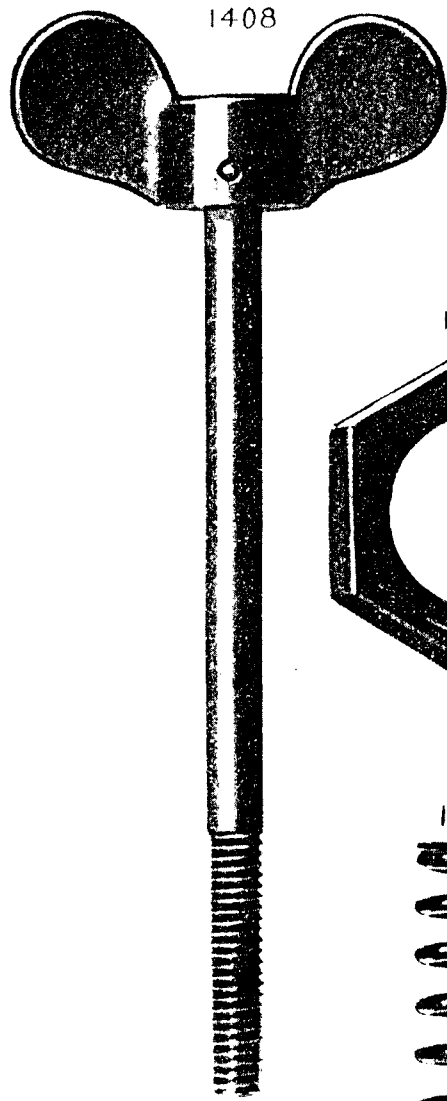
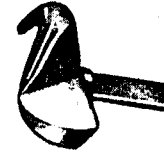

PLATE 9307—FULL SIZE

68519



51874



68526

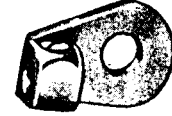

68520

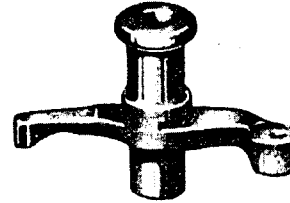

68521

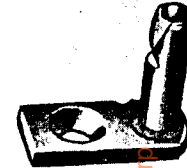

990



229



68517



64964

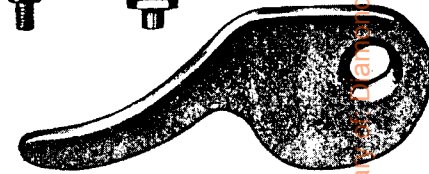

68522

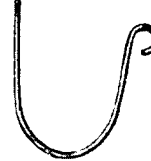

68546

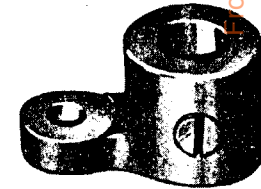

For the library of the National Needle Company

PLATE 9308—FULL SIZE

68534

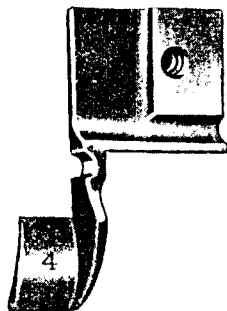

68536

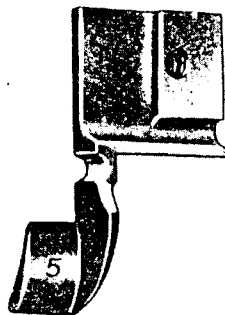

68538

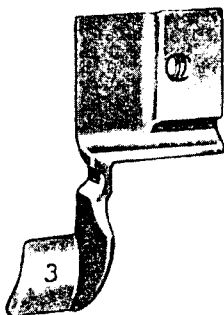

68540

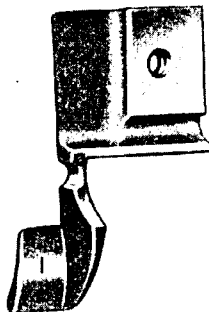

68509

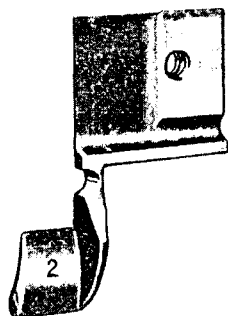
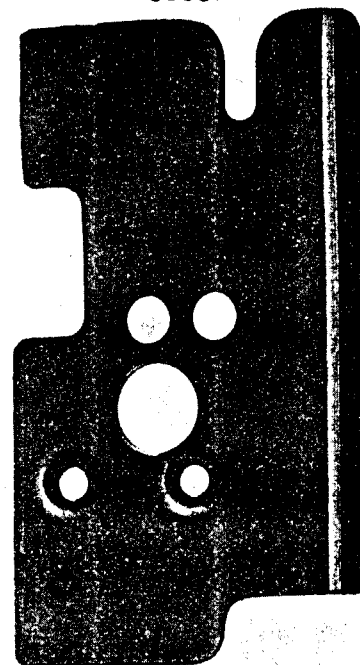

PLATE 9309—FULL SIZE

68531



68545



68523

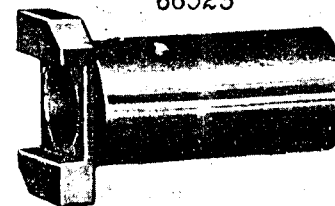

68530



68532



68527

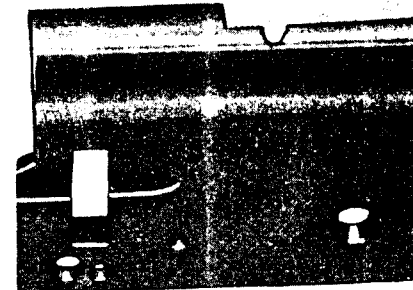

From the library of: Diamond Needle Corp